



TYRON

The strong Viking!





Always your partner!

Reliable. Competent. Flexible.

If you are challenged to recycle a few thousand tons of material every day, you may not need a machine initially - but you will need the best possible advice! With a team of highly qualified specialists, and over 30 years experience, we are at your disposal for exactly this purpose. Avoid mistakes early in the planning stage and invest for the long term - product loyalty is the key to your success!

We are available for project consulting in both the planning and design phases, for new projects, as well as for existing operational processes with potential for improvement. The most suitable machines for your individual requirements are the products of every consultation.

We have the competence to plan and install your recycling plants ATEX-compliant. In addition, we can give you important ideas on how to optimise the workflow, efficient machine use and the design of recycling plants. In addition - besides achieving maximum performance - aspects of efficiency and environmental protection also play an important role.

For individual advice, please contact your HAAS sales contact or info@haas-recycling.de





HAAS guarantees...

Quality

- „Made in Germany“
- High-quality materials and components
- Processing at a consistently high level
- Particularly robust construction
- Long service intervals
- Minimised downtime
- Readily available spare parts

Customer focus

- „HAAS customised“ - tailor-made machines and plants
- With our „HAAS Roadshow“ we are regularly on demo tour. Your desired HAAS machine on your input material and in your location. During a live demonstration at your site, you can convince yourself of the exceptional performance of HAAS machines.



Shredder

Shredding - Breaking - Chipping



Screening & Separating Technology

Screening - Sifting - Separating



Loading & Unloading Systems

Docking - Filling - Emptying



The Viking, in the world of primary shredders, convinces with efficiency, reliability and flexibility!

1999 was the launch of the first HAAS TYRON.

The „New Edition 2.0“ was first produced in 2015. Since 2019, all TYRONS are delivered as this version.



30 years of know-how

TYRON'S POWER:

- **Intelligent 2-shaft shredding**
HAAS Standard for 20 years
 - **Powerful and aggressive**
 - **Dynamic shredding programs**
 - **Self-cleaning, no wrappage/blockages**
 - **Shaft speed infinitely variable**
 - **Rotating direction and reversing times variable**
- **Reliable, minimised downtimes, highest up-time**
- **Solid construction for longer life**
- **Highly effective sound insulation**
- **Maintenance-friendly access**
- **Uniquely low operating cost**



Telematic data **receiving and analysing**

The HAAS Tracking Portal is the easiest way to get all telematic data of the HAAS shredder onto the screen. The system allows access from any PC, tablet or smartphone connected to the Internet, anywhere in the world.

You can check performance, status and operating data of each machine in a compact way, from the start of operation to the present moment.



Painting **in your company colour**

Do you want your HAAS TYRON to come to in your corporate colours? We would be pleased to paint your machine according to your requirements and desires. All we need is your RAL numbers and the service is free!



combined in one machine!



XL-Power Upgrade for even more power

Reach your target in the shortest possible time. If you wish, we can fit even more power and performance into your TYRON. With a dynamically reinforced hydraulic system, the machine achieves a significantly higher throughput capacity. The more powerful machines can be identified by the marking „XL“!



Energy Efficiency thanks to HES

The latest exhaust emission standard Stage V has already been integrated into our system. All HAAS TYRON'S are fitted with engines of the latest generation. However, that was not enough for us. In addition, all machines are equipped with „HES“ HAAS Energy Saving. Whenever you give your Viking a break, the intelligent control system reacts. The power of the machine is reduced, fuel consumption and noise pollution are minimised, as a result.



1999



2008



TYRON 2.0

Quality permanently improved!

A close and trustful cooperation with dealers and customers is the basis for the continuous development of HAAS machines and plants. We always have an ear for ideas and suggestions from our customers. New HAAS machines therefore always include realised customer requirements and are the foundation of long-standing, trusting partnerships!



 Shreds even the most difficult materials

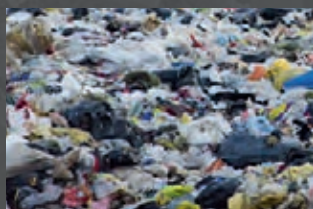

MSW
Municipal Solid Waste



Domestic Waste



Mattresses



Paper Rolls

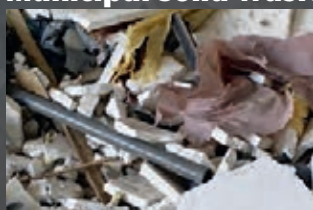

C&D Construction & Demolition Waste



Commercial waste

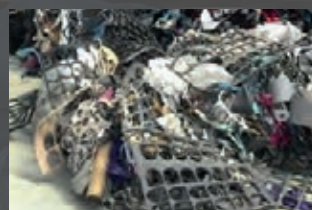

Industrial Waste



Bulky Waste

Easily up to
100 t/h throughput



Railway Sleepers



Pallets



Green Waste



Aluminum



Waste Wood



Cable Drums



Roots



End of life PVC frames



2000-E XL 2.0

15 m

505



TYRON 1500

TYRON 2000

TYRON 2500

mobile/diesel



- 350 HP / 257 kW
- XL-Power 400 PS / 294 kW



- 350 HP / 257 kW
- XL-Power 400 PS / 294 kW



- 770 HP / 566 kW



TYRON 1500-E

TYRON 2000-E

TYRON 2500-E

stationary/electric



- 2x 90 kW
- XL-Power 2x 110 kW



- 2x 110 kW
- XL-Power 2x 132 kW



- 2x 160 kW

The core

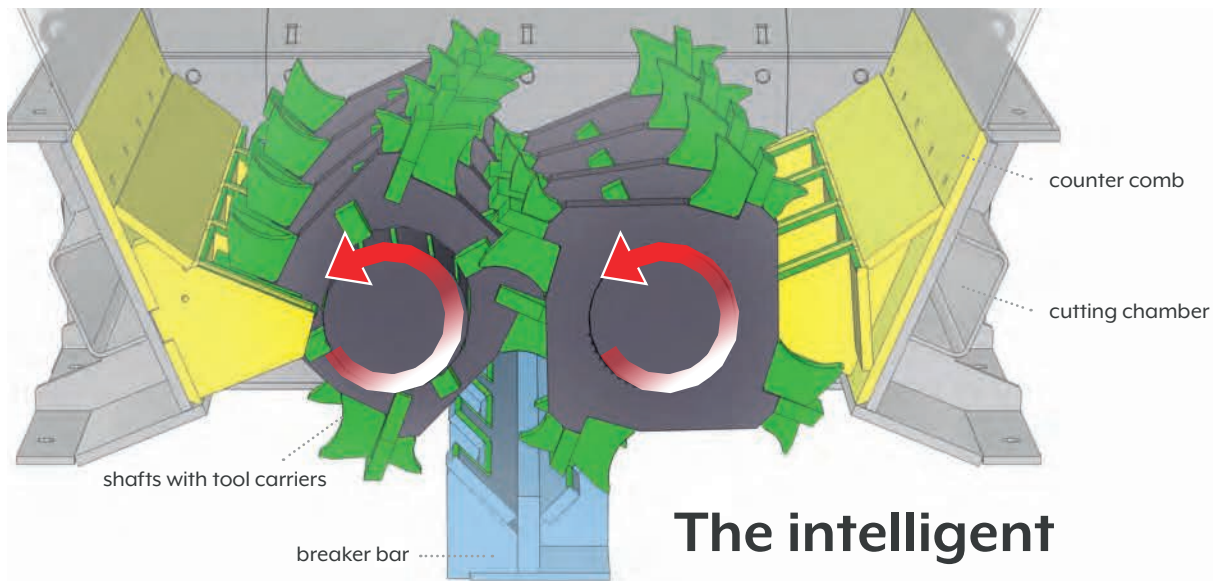

The intelligent twin-shaft system

...makes the HAAS TYRON to the ideal solution for the effective shredding of the most difficult materials.

Two independently driven shafts ensure highest flexibility and keeps the infeed material continuously in motion.

Shaft speed, rotating direction and reversing times can be flexibly adjusted by the customer.

The material is shredded in the forward and additionally in the reverse rotation. This ensures **maximum throughput** even when reversing!

The shredding process is sensor-monitored. In case of overload, e.g. due to an impurity, an automatic reversal is initiated and the tools are protected against damage. The wrapping of wires and long-fibre materials is avoided. Wear and down-time are therefore minimized compared to synchronous running shredders and costs are significantly reduced.

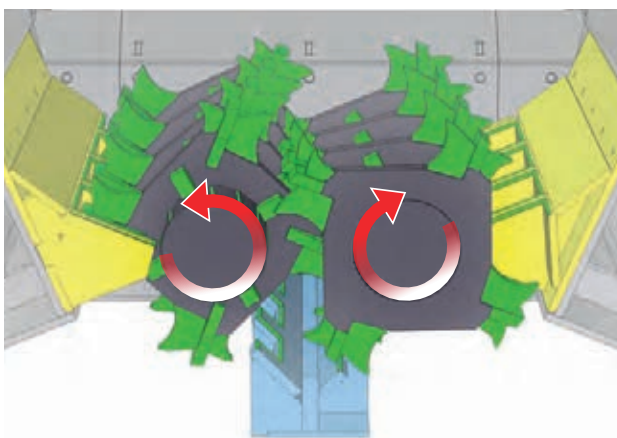
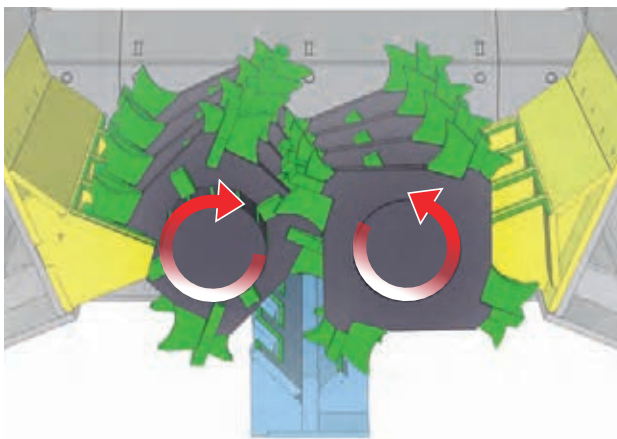

In the standard package... Hardfaced tools ex works!

Preventive wear protection, that saves you costs and working time compared to tools that are subsequently hardfaced!

of our TYRON

The appropriate tool - for every application

We can match the tool configuration optimally to your specific requirements and thus maximise the potential of your TYRON!

The particle size of the shredded material is defined by the number of **tool carriers** and **cutting tools** on the **shredding shafts**.

The **particle size can be varied** depending on the number of carriers on the cutting tools and the distance to the **counter combs**.

In addition to the shredding tools and counter combs, the **breaker bar** determines the particle size. This bar is located below the shredding shafts and is individually configured according to the specific task. The breaker bar also protects the downstream conveyor belt from damage.

Tool configuration TYRON 2000

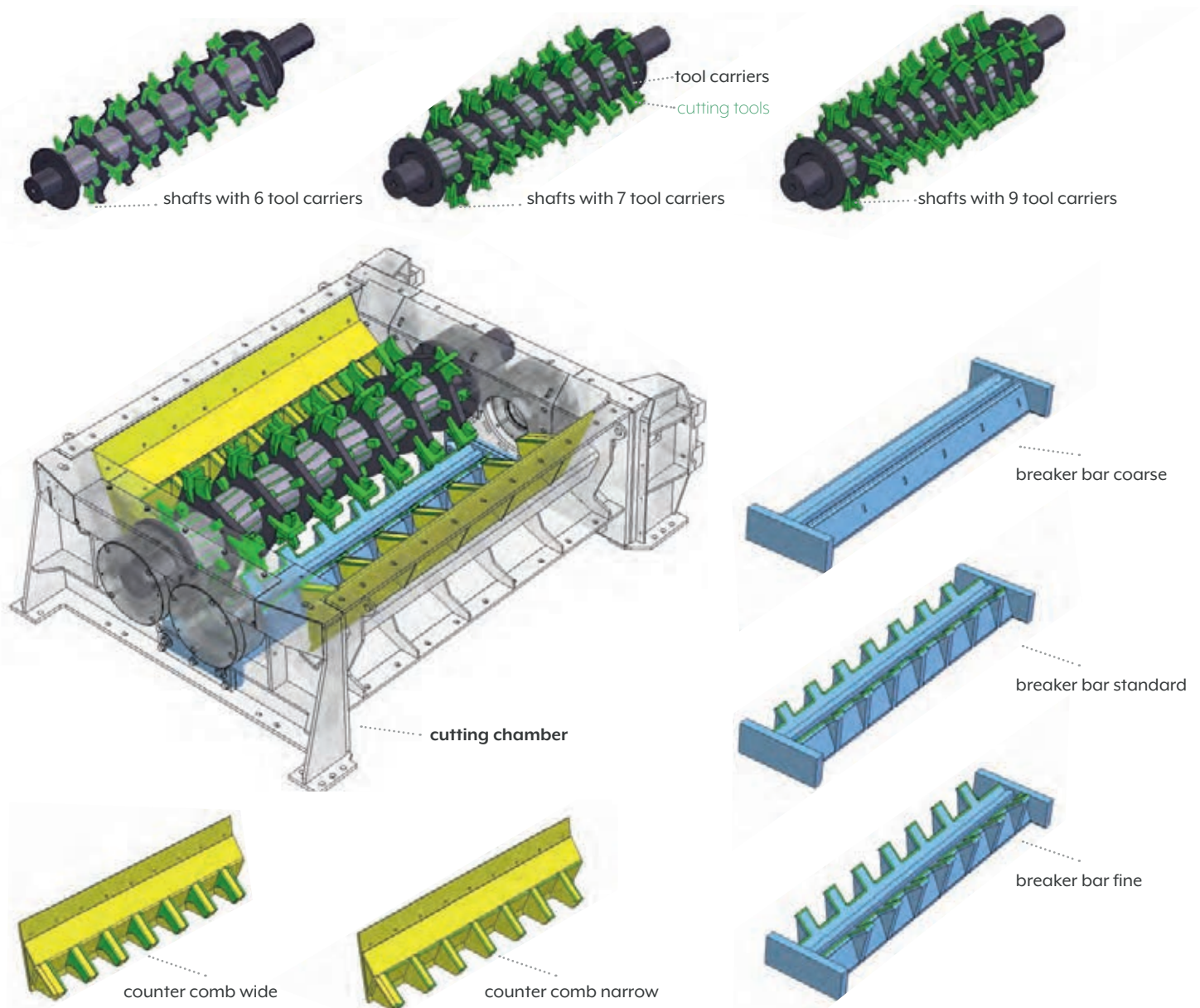

Exclusive features...

TYRON Mobile



HAAS Tracking Portal

With this online platform you have a clear overview of the machine data and operating conditions of your HAAS machines and plants.



TYRON Hybrid Version

With this mobile version you get a modern and sustainable machine concept. The electro-hydraulic power reduces your energy costs by up to 80% compared to diesel-powered mobile machines..



XL-Power Upgrade

The upgrade with reinforced hydraulic system convinces with 30 % more power and through-put!



Flexible mobility



TYRON on tracks

- high mobility onsite
- additional rubber shoes provide best mobility on hard ground while protecting your concrete floor



TYRON with wheel axle/drawbar

- easy moving onsite by wheel loader



TYRON on trailer

- the option for the frequently moved machine
- incl. road approval
- maximum speed up to 80 km/h



Efficient Drive



Scania CV AB

Scania diesel engines

- from 257kW up to 566 kW
- low fuel consumption
- only 1750 rpm
- latest exhaust emission technology (Stage II version and stage III version on request)
- HES- HAAS Energy Saving

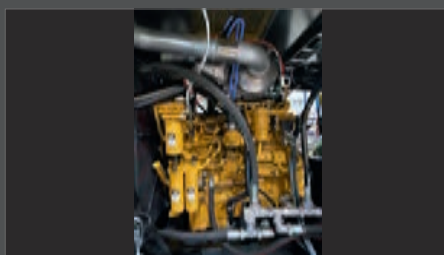

CAT engines on request



... individually configured

TYRON Mobile

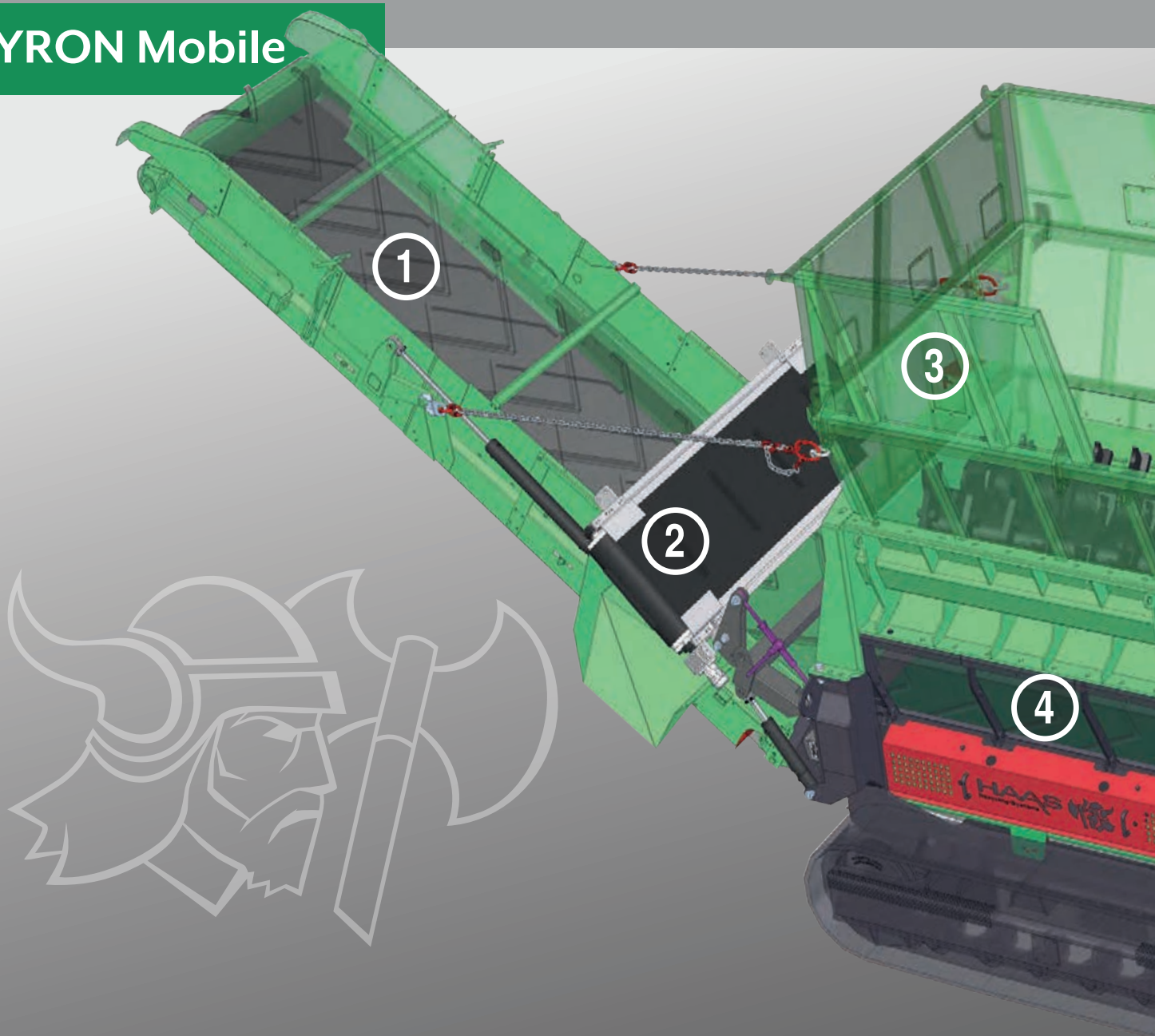

Discharge Conveyor

- 1400 mm wide
- individual discharge height up to 5.1 m
- with steel core or MOR conveyor belt
- conveyor speed adjustable
- adjustable tilt angle
- with stainless steel head drum (for use with magnet)



Powerful overband magnet

- hydraulically height adjustable
- tilt angle additionally manually adjustable
- extra strong neodymium magnet available



Dust minimisation

- minimise dust emissions in the areas:
 - feed hopper
 - discharge conveyor
 - material discharge

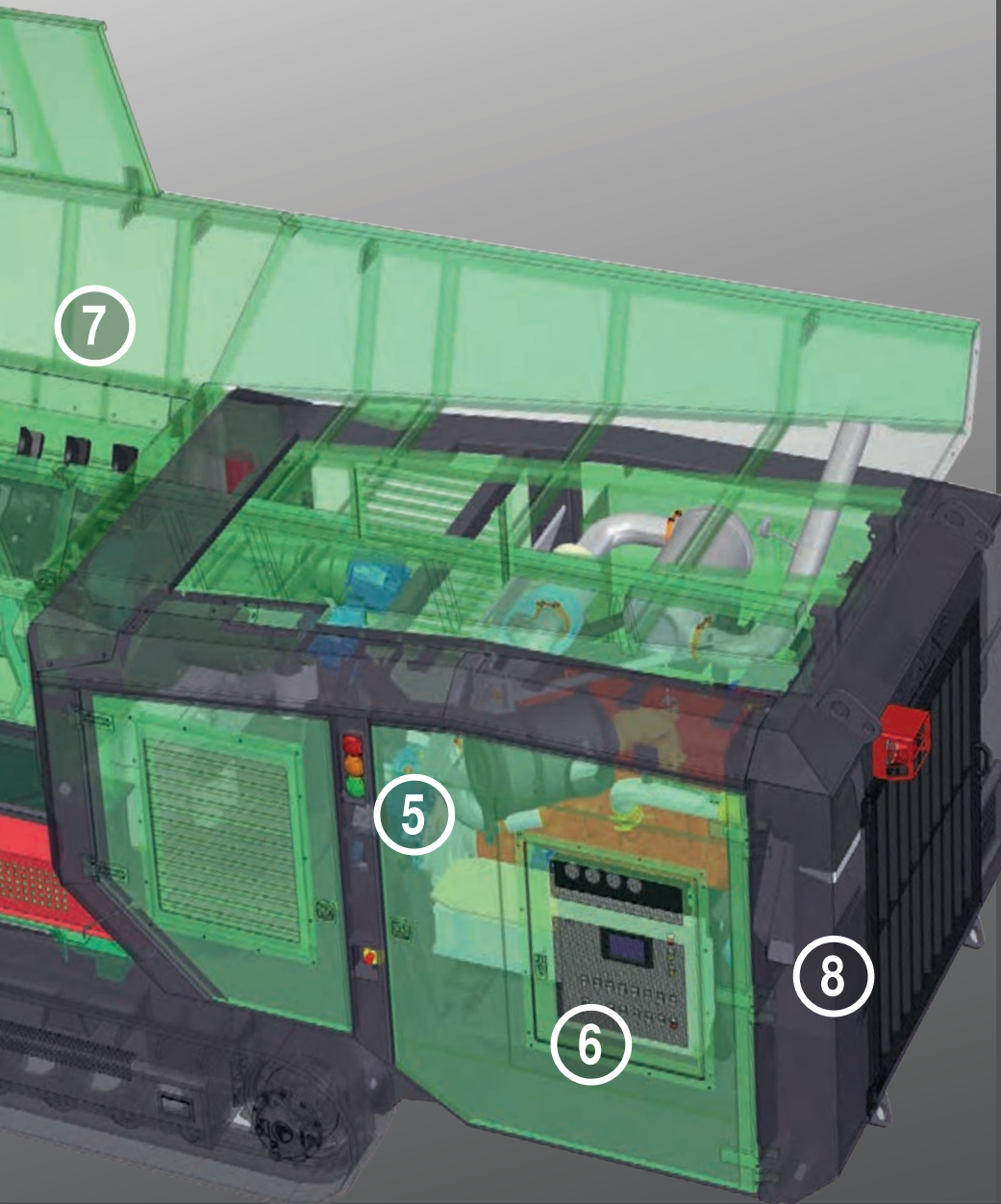

Big feeding area

- tilting hopper with load dependent control
- extended feeding area due to additional hopper extension



Remote control

- start/stop automatic mode
- moving the machine
- magnet height adjustment
- reversing the shafts
- operating the tilting hopper
- emergency stop button



Maintenance friendly shredding compartment

- wide opening side doors
- easy access
- highest safety standard secured with key transfer system



Generously sized engine compartment

- integrated acoustic insulation
- Cleanfix® reversible fan
- electric pump for hydraulic oil
- heating (display, hydraulic tank)
- traffic light system for operating status
- fire extinguishing system



Multifunctional control

- control board and management of the machine data
- configuration of dynamic shredding programs
- input/output test electrical system
- all languages available
- diagnosis via HAAS Tracking Portal
- WIFI access (machine data on tablet/mobile phone)

HAAS customised

TYRON Stationary

In stationary recycling plants the TYRON is very often used as the first machine of a processing line. The pre-shredded material can be further processed with subsequent machines. We configure your stationary shredder according to your individual requirements and conditions.



HAAS Tracking Portal

With this online platform you have a clear overview of the machine data and operating conditions of your HAAS machines and plants.



XL-Power Upgrade

The upgrade with reinforced hydraulic system convinces with 30 % more power and throughput!



ATEX-Compliant

If required, we can plan and deliver the primary shredder ATEX-compliant for use in potentially explosive areas.



Facilitated service access



Maintenance platforms

- access door to the grinding chamber secured with key transfer system

Flexible heights



Steel support frame

- individual solutions possible depending on local conditions



Efficient Drive

Customised feeding area



Powerful electric motors

- up to 2x 160 kW
- soft start instead of star-delta circuit (reduction of starting currents by 25%) to avoid peak currents

Tailor-made feed hopper

- extended feeding area due to additional hopper extensions
- individual hopper solutions for maximum throughput



Customised Solutions

TYRON Stationary

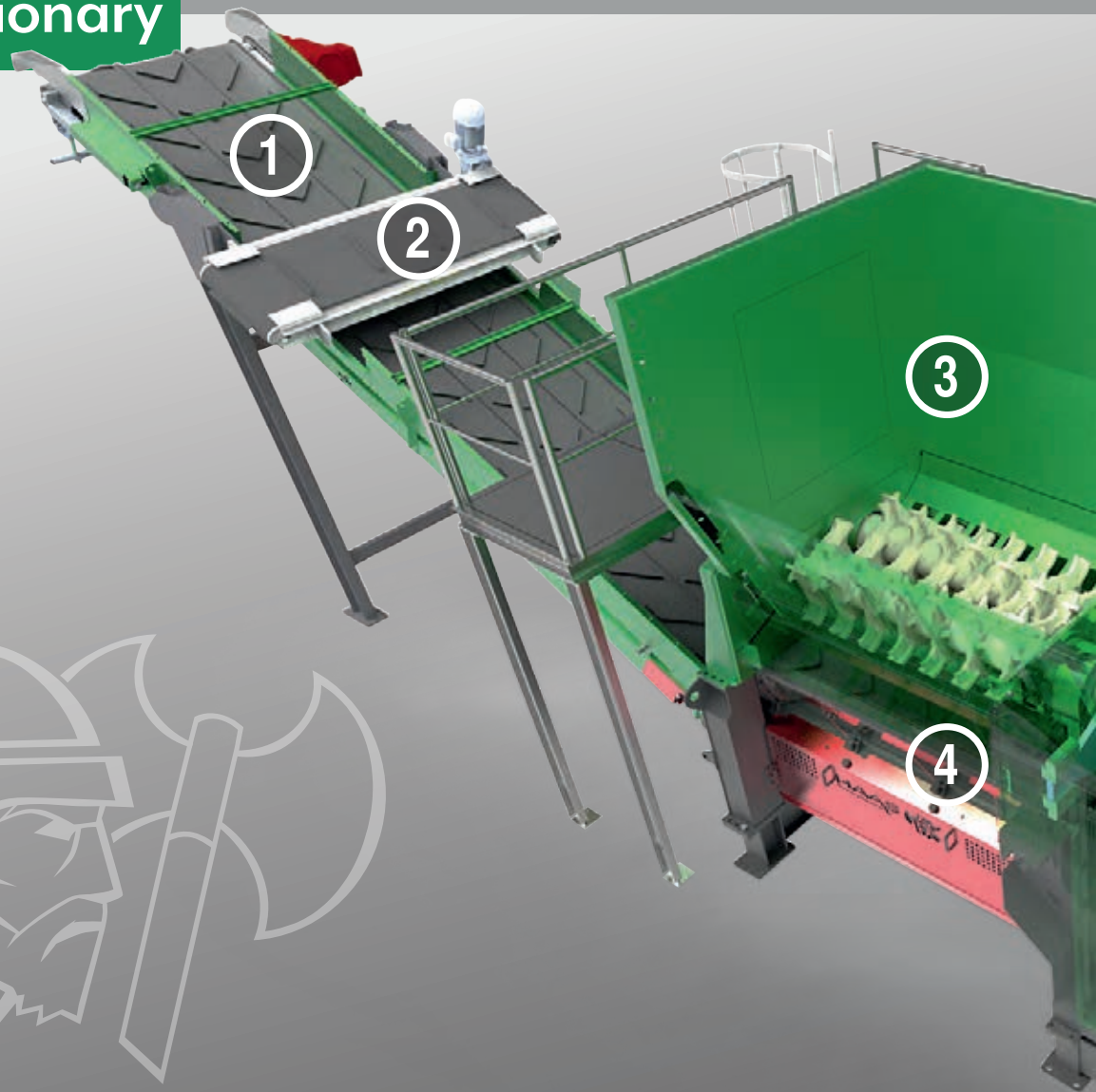

1



Discharge Conveyor

- 1400 mm wide
- individual discharge height
- on request with steel core or MOR conveyor belt
- conveyor speed adjustable
- adjustable tilt angle
- with stainless steel head drum (for use with magnet)

2



Powerful overband magnets

- optional electric or permanent magnets
- installed across or inline

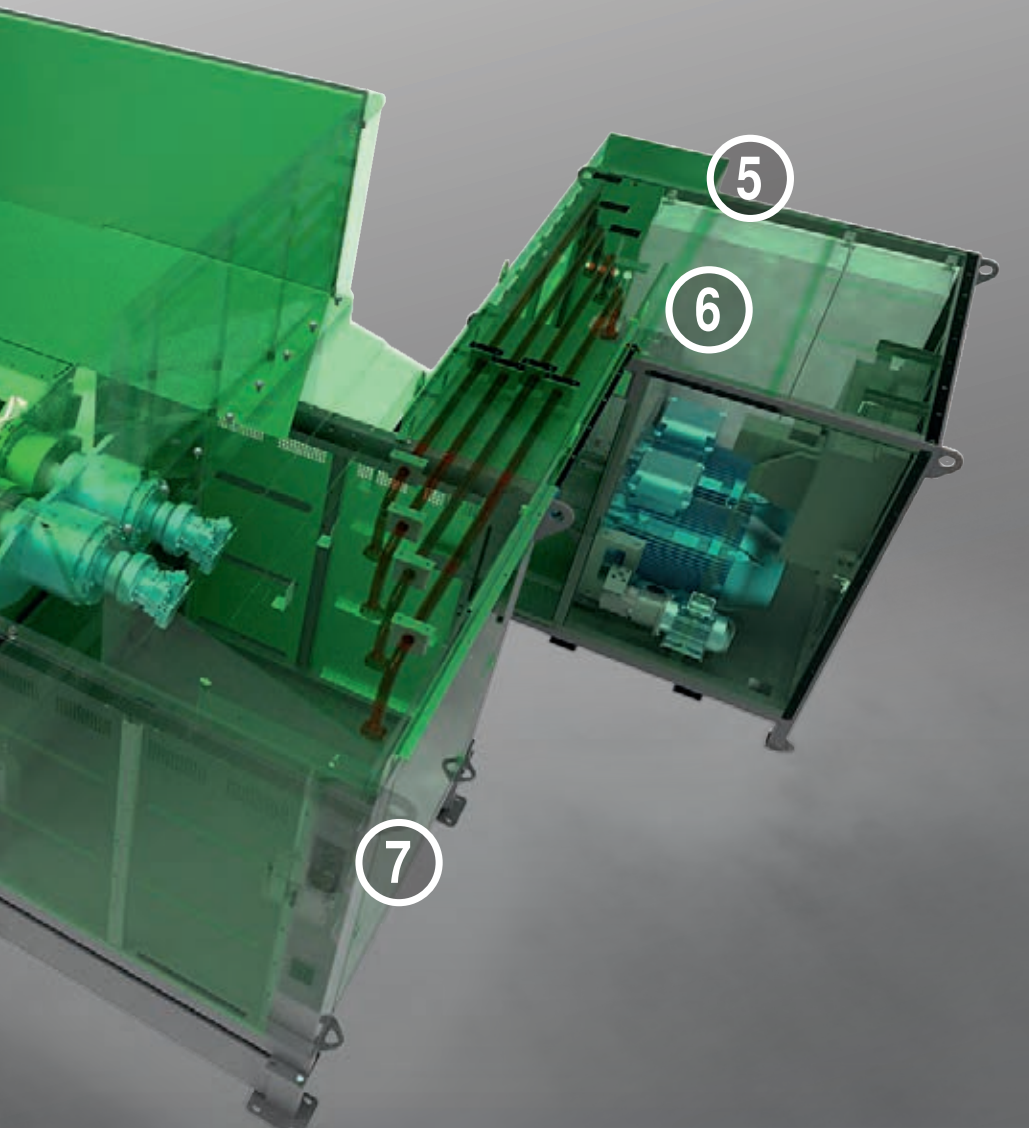

Powerpack

- separate drive unit
- safety plus thanks to the encapsulated hydraulics
- optimal acoustic insulation
- reversible fan
- electric pump for hydraulic oil
- heater for hydraulic oil
- fire extinguishing system



Remote control

- start/stop automatic mode
- magnet height adjustment
- reversing the shafts
- operating the tilting hopper
- emergency stop button



Dust minimisation

- minimise dust emissions in the areas:
 - feed hopper
 - discharge conveyor
 - material discharge



Maintenance friendly shredding compartment

- wide opening side doors
- easiest access
- highest safety standard secured with key transfer system



Multifunctional control

- control board and management of the machine data
- configuration of dynamic shredding programs
- Input/output test electrical system
- all languages available
- diagnosis via HAAS Tracking Portal
- WIFI access (machine data on Tablet/mobile phone)

TYRON Combinations

TYRON Mobile



TYRON & ARTHOS The mobile hammermill shreds pre-shredded waste wood, green waste, RDF - Refuse Derived Fuel and PVC waste thoroughly and quickly.



TYRON & HSS 6000 The mobile HAAS starscreen is the perfect screening system for green waste, roots or waste wood. A defined particle size is screened out and the oversize is returned to the primary shredder.



TYRON & HEXTRA Ecostar's patented „dynamic“ screen guarantees maximum performance even with materials that are difficult to separate. With this screening machine you can produce either 2 or alternatively 3 fractions.

HAAS recycling plants

TYRON Stationary



Waste wood recycling plant In Cologne the high capacity processing plant for the treatment of approx. 120,000 tons of waste wood per year, includes the stationary TYRON as the first machine of the line, which shreds waste wood of classes A I, A II and A III.



Light Scrap Compact Plant The TYRON -here with separate Power-Pack- is used for shredding aluminium and light scrap. In this way the optimum grain size for the following ferrous and non-ferrous separation is achieved.



Shredding and sorting plant: In Sweden the TYRON „works“ in a combined waste wood and commercial waste recycling plant. The shredding program can be changed at the push of a button and guarantees maximum flexibility.

HAAS Machine Service



Original HAAS Spare Parts

Only with the original, you are on the safe side. Experts choose HAAS because performance and costs are their main concern. HAAS spare parts are high-quality parts from state-of-the-art production and are subject to rigorous testing and continuous quality control.



Customised Service Packages

We provide you with spare and wear parts tailored to your specific needs. Packages at fair prices guarantee you foreseeable machine costs and, additionally, minimum downtime.



HAAS Tracking Portal

The HAAS tracking platform allows both you and us to check the operating status of HAAS machines and plants. In the event of a malfunction, we can help you by remote diagnosis in a cost-effective, fast and uncomplicated way! No inspection or maintenance is forgotten.



Economical. Reliable. Value stable.

Wear parts of shredders are exposed to enormous loads - therefore, when you purchase your shredder, decide for best quality and thus for the success of your company! Your satisfaction is our greatest asset, HAAS machines are therefore designed for highest quality!



Contact us:
+49 2661 9865-0

Your advantages with HAAS:

- spare parts shipment on request within 24 hours
- high availability
- qualified, solution-oriented consulting
- highly skilled spare parts experts
- quick help in identifying the required spare part



Powerful 2nd hand machines and demo units

Strong design, heavy-duty construction, and durability - HAAS machines convince with their long-term value and are highly sought-after even as used machines.



The „ Young Vikings „ are strictly tested HAAS demo machines in top condition, with very low operating hours and include a comprehensive warranty package“.

The „ Skilled Vikings“ are HAAS pre-owned machines that have already proven themselves extensively in the field. HAAS machines are known for their extreme durability and quality. These very experienced Vikings pass an extensive quality check and a complete overhaul. During this process, all technical and mechanical components are checked, replaced if necessary and, as a rule, body parts are repainted. You will receive a detailed list of the renewed spare and wear parts.



HAAS Machine Refurbishment



Photo comparison: HAAS TYRON with 15000 operating hours before and after refurbishment.

If required, we can offer you a reconditioning of the shafts or even a complete reconditioning of your HAAS machine. All technical and mechanical components are checked, replaced if necessary and body parts are repainted.

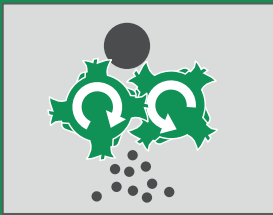

Shredder



Screening & Separating
Technology

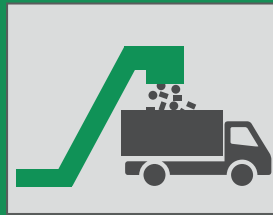

Loading & Unloading
Systems

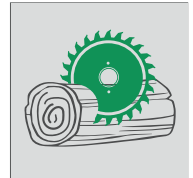
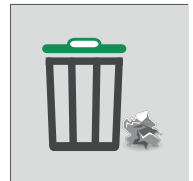
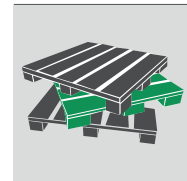

HAAS[®]
Recycling-Systems

HAAS Holzerkleinerungs-
und Fördertechnik GmbH
Unter den Weiden 6
56472 Dreisbach / GERMANY

Tel.: +49 2661 9865-0
Fax: +49 2661 9865-20
E-mail: info@haas-recycling.de

